

5 cm

SECTION A

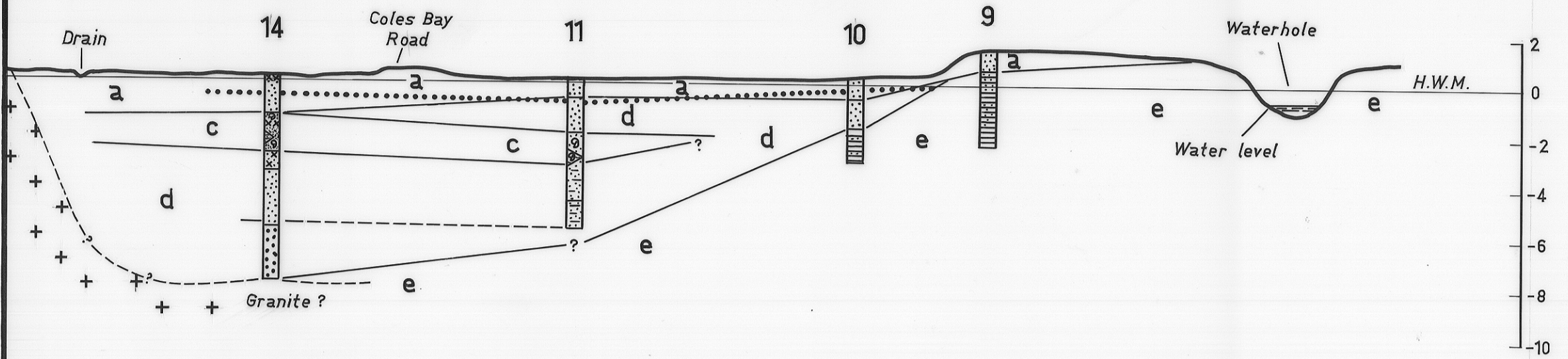

SECTION B

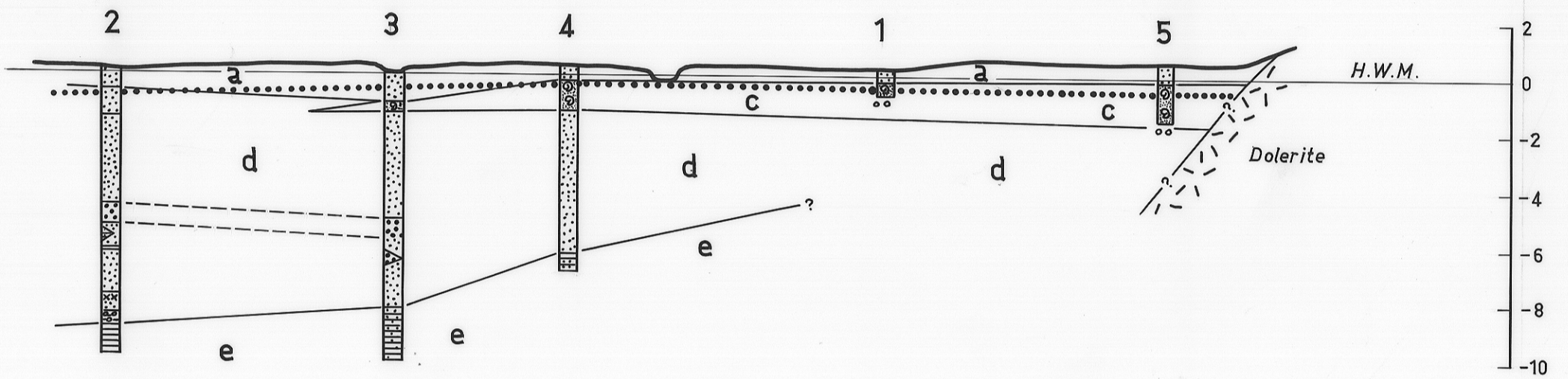



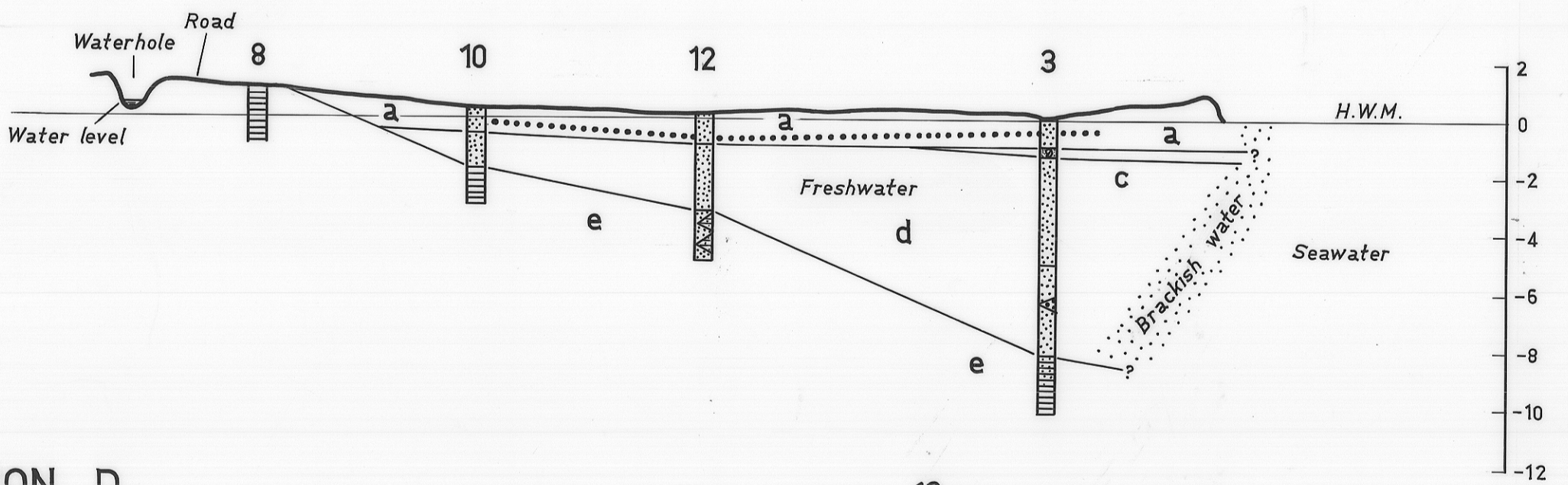



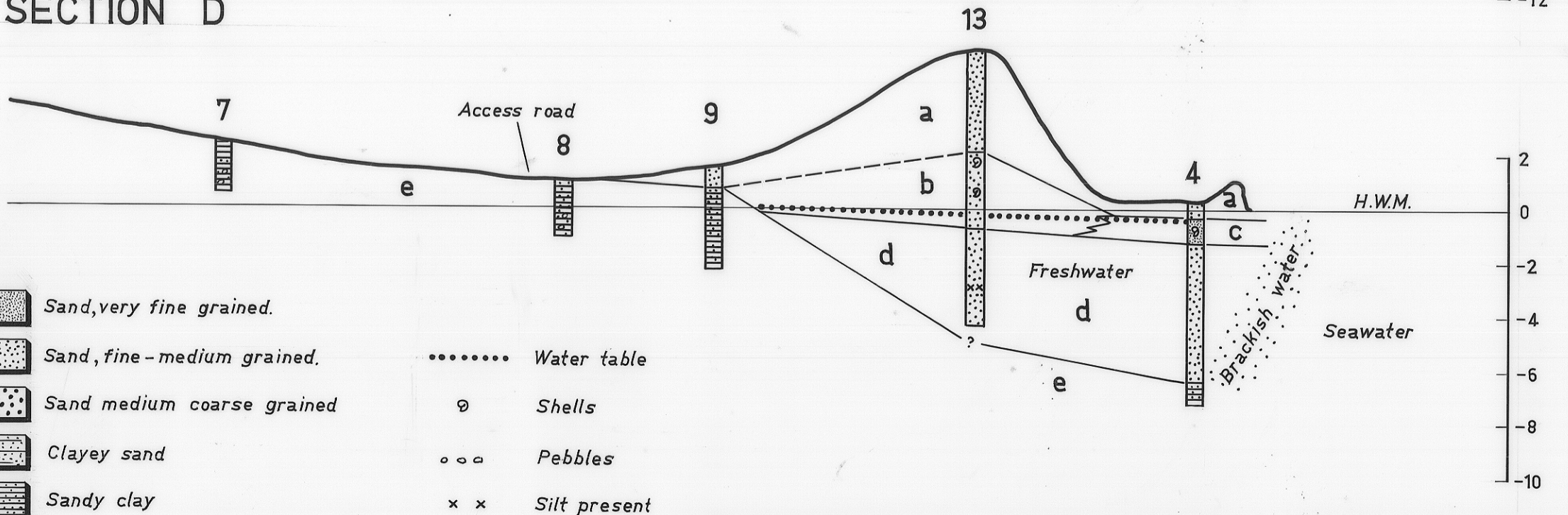

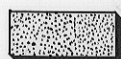
SECTION C

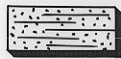
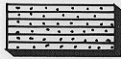

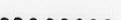
SECTION D



-  Sand, very fine grained.
-  Sand, fine-medium grained.
-  Sand, medium coarse grained.
-  Clayey sand.
-  Sandy clay.
-  Clay.
-  Water table
-  Shells
-  Pebbles
-  Silt present

0 50 100m  
HORIZONTAL SCALE

GEOLOGICAL SECTIONS - SWANWICK

GEOLOGIST: W.C. CROMER

OCT. 1980