

3544

(a)

250 SMALL QUARTZ (YZ Sections)
4, 3, 2, 1, 0%



(b)

500 SMALL QUARTZ (XZ+YZ Sections)
3, 2, 1, 0%

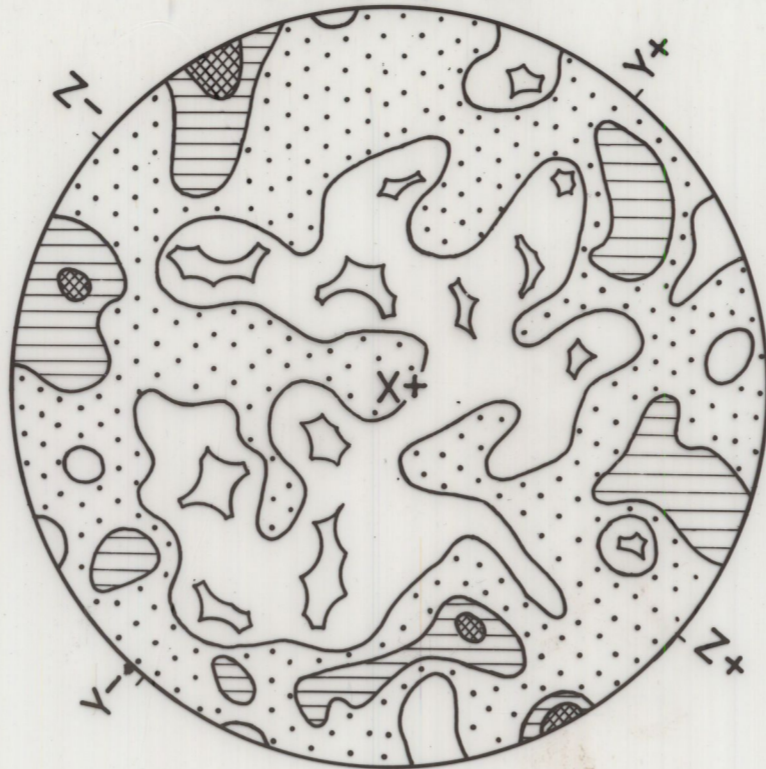

(c)

250 SMALL QUARTZ (XZ Section)
3, 2, 1, 0%



(d)

375 LARGE QUARTZ (XZ+YZ Sections)
4, 3, 2, 1%

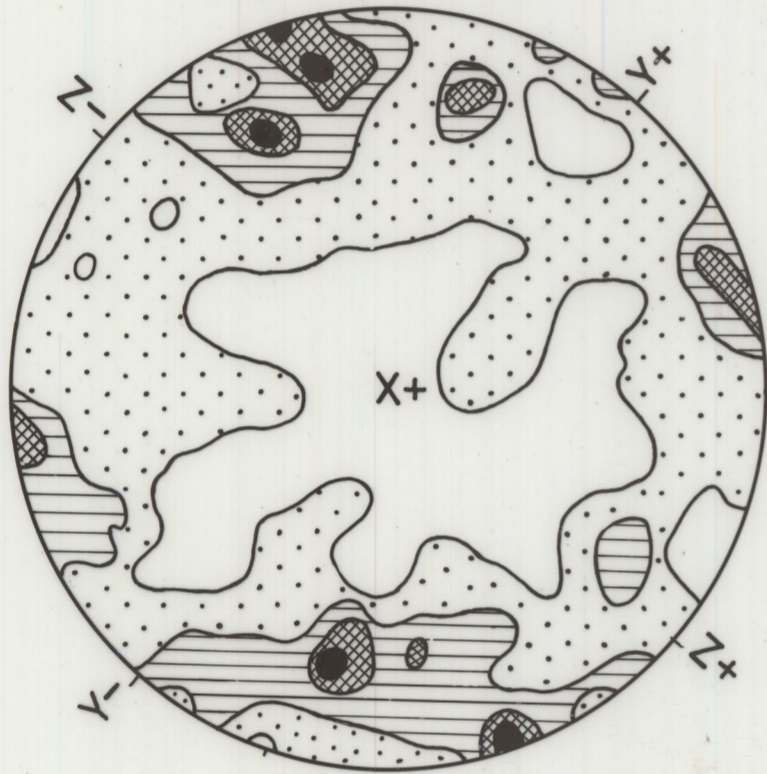

(e)

x LAMELLA POLES
• OPTIC AXES

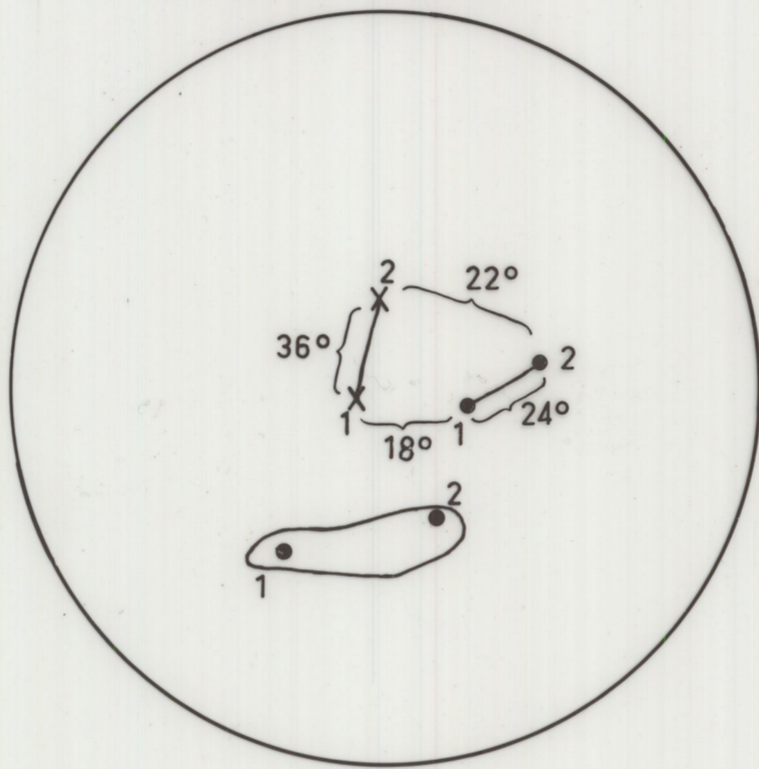

(f)

200 MUSCOVITE (YZ Section)
17, 15, 12, 7, 5, 2, 0%

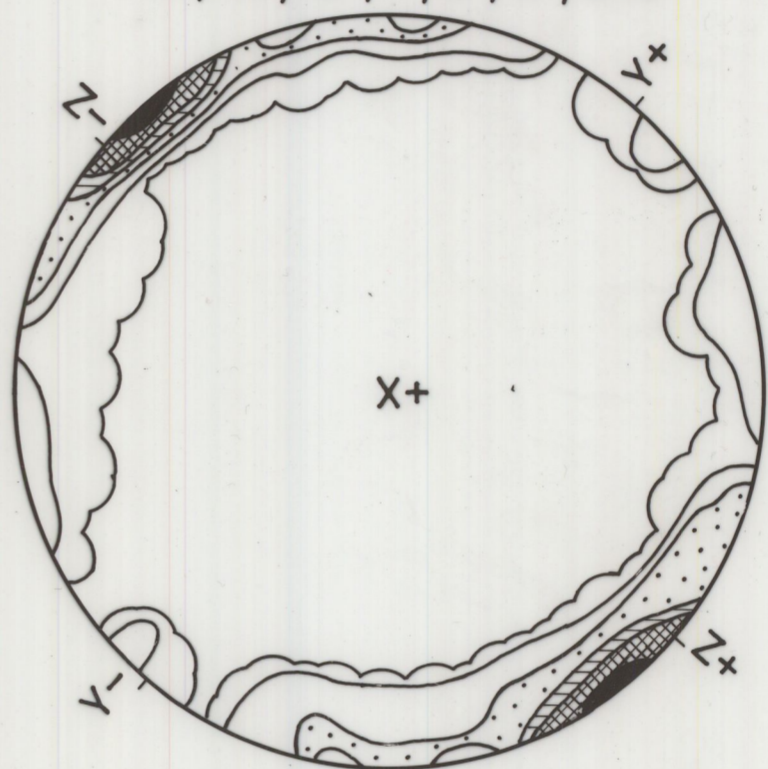

(g)

125 LARGE QUARTZ (YZ Section)
6, 4, 3, 2, 1%

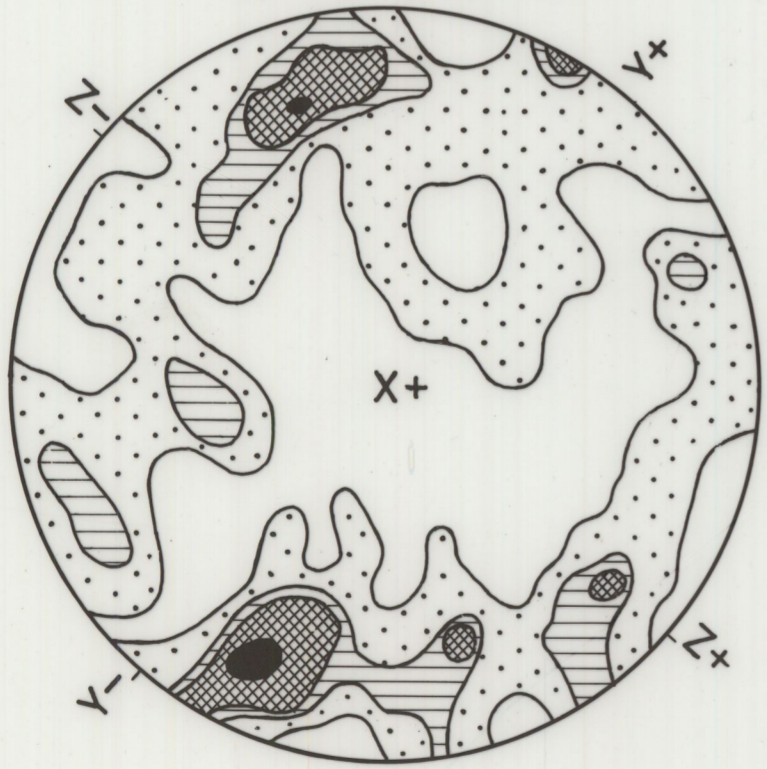

(h)

250 LARGE QUARTZ (XZ Section)
4, 3, 2, 1%

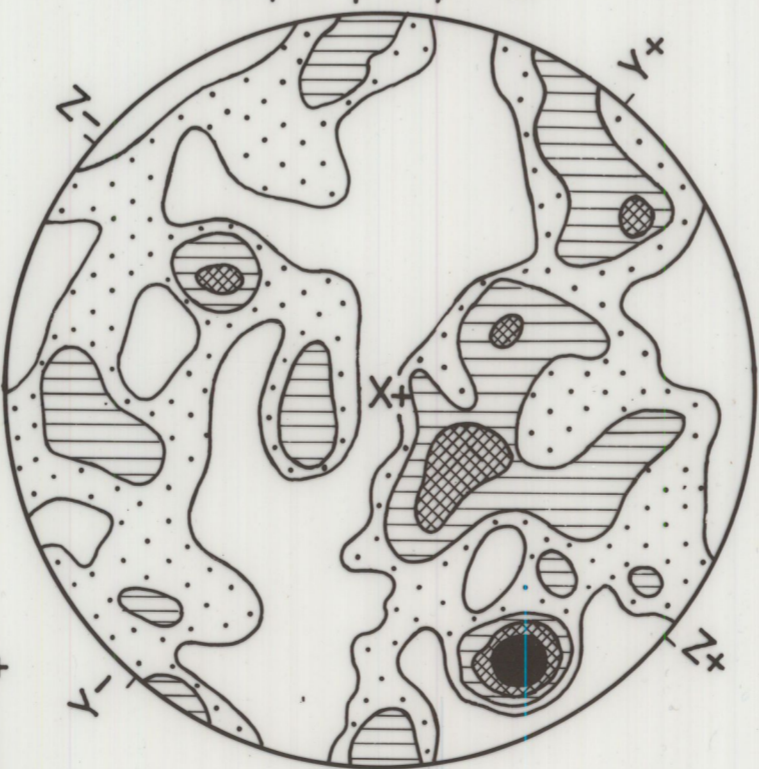

(i)

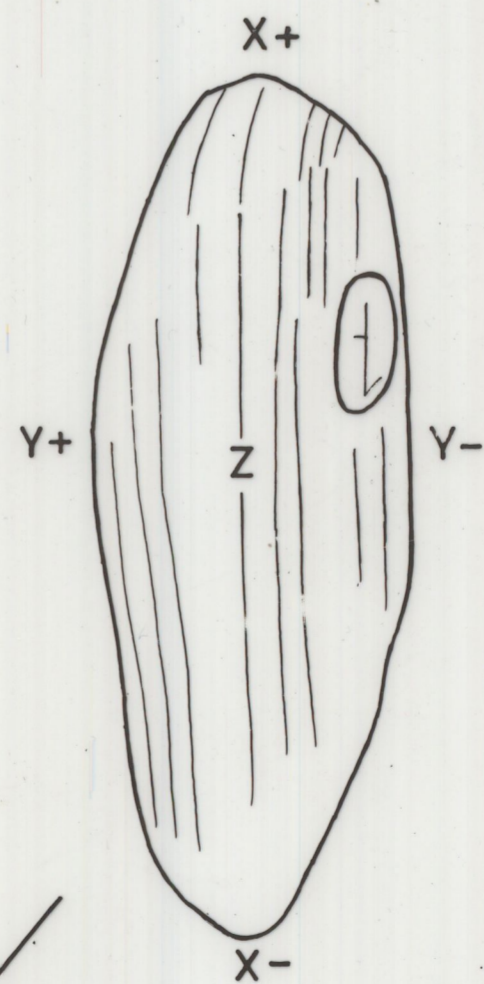

(j)

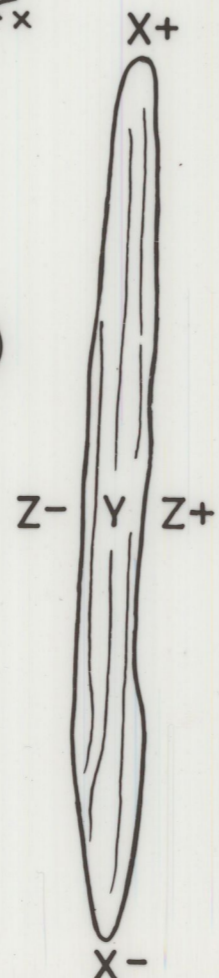

(k)

